

ASTRALPOOL 

RolaChem Models

RP 9 pH only

RO 9 ORP only

RC 9 ORP and pH Combined

INSTALLATION AND OPERATING INSTRUCTIONS



Dear Customer,

Congratulations, you have made a great choice in purchasing a RolaChem controller by AstralPool. Your RolaChem dosing system will monitor and control the pH and/or ORP level in your swimming pool to give you the most crystal clear water possible. These instructions cover the following models:

RC 9 pH and ORP (acid and sanitiser sensing and dosing)

RP 9 pH only (acid sensing and dosing only)

RO 9 ORP (sanitiser sensing and dosing only)

Please ignore reference to pH or ORP if it is not fitted to your unit.

Swimming pool chemistry is quite interesting and dynamic. There is no one setting that is right for every swimming pool or spa. After installation, let the Rola Chem machine settle down over a couple of days and then if necessary alter the setting to suit your pool or spa.

In the automatic models, the chlorine level is controlled using the ORP principle (which is a better measure of the sanitising ability of chlorine).

- ORP (Redox) measures **ACTIVITY** in millivolts (mV) of all oxidising chemicals. Test Kits and strips measure the **QUANTITY** of Chlorine/Bromine in PPM only.

- ORP of 650mV or above means water is clean and safe, regardless of qty. of chlorine/bromine, provided ORP sensor is clean, calibrated and functioning OK.

- ORP readings can vary depending upon water chemistry like pH, TDS. T.A. and stabiliser levels. Ensure that these levels are correct. Consult your shop/technician.

If large quantities of chemicals are dumped in the pool water, this excess quantity should be circulated well and then, allowed to settle down before this machine starts to give true readings.

If you have any questions please contact your AstralPool Supplier or us directly.

 Product is designed to run with ACID diluted to water to acid ratio of 2:1 should always be followed as the machines dosing rate is formulated around the diluted solution. Using neat acid can lead to overdosing the pH level.

Note: The RolaChem dosing unit is not intended for use by young children or infirm persons without supervision. Please ensure that young children are supervised to ensure that they do not play with the Chlorinator.

INDEX

RC9 – INTRODUCTION	3
RC9 – PLACEMENT OF CHEMICALS, ROLACHEM AND CONNECTIONS.....	4
RC9 – INSTALLATION SET UP	5
RC9 – TIMER SET UP (ONLY IF TIMER SELECTED).....	9
RC9 – ORP AND/OR PH SET POINT ADJUSTMENT	10
RC9 – ORP AND/OR PH MANUAL DOSING	10
RC9 – ORP AND/OR PH PROBE CALIBRATION	12
RC9 – ORP AND/OR PH FAULT WARNING INDICATORS.....	12
RC9 – MAINTENANCE.....	13
RC9 - TROUBLE SHOOTING GUIDE.....	13
RC9 – MAINTENANCE SCHEDULE	14
WARRANTY.....	15

RC9 – INTRODUCTION

Before starting up your RolaChem controller, pool and spa water must be balanced correctly. The correct levels can be seen below. **This appliance is not designed to bring a pool into balance; it is designed to maintain a balanced pool.** Allow 24-48 hours after switching on unit for sensing and dosing to be 100% accurate, the inbuilt fuzzy logic controller bases its precision dosing of chemicals by looking at historical dosing rates. After 24-48 hours, unit should be work at its optimum performance.

Recommended chemical ranges (depending on pool location and pool surface) are:

CHLORINE: 1 - 3ppm pH 7.2 - 7.8
TOTAL ALKALINITY: 80 - 150 mg/L
PHOSPHATES FREE

STABILISER: 30 - 50 mg/L
CALCIUM HARDNESS: 90 - 300 mg/L

PLEASE READ ALL THESE INSTRUCTIONS CAREFULLY BEFORE INSTALLING & OPERATING THE UNIT AND LEAVE THE MANUAL ON SITE FOR OWNER/OPERATOR'S USE.

RolaChem dosing systems should operate only when the pool filtration system is running. The unit must not be connected without adequate earth connections and a voltage other than 230-240V (unless specified otherwise)

Before installing the unit in position on the wall or post, the length of the PVC tubing provided should be measured and taken into consideration. To avoid loss of water from the system, close all stop valves before cutting any lines.

Connection of lines (see illustration page 5)

Install the Inline Mixing Chamber into the "return" line. Cut an appropriate piece out of this line and glue the mixing chamber in position, using a PVC adhesive. Thread the PVC tube through the hole in the cap or shoulder of the chemical container and fit the non-return or check valve and the weight. Ensure that the non-return valve is fitted correctly (arrow indicates the direction of flow) Drop the weight, with the non-return valve into the bottom of the container.

TIP: Soaking the ends of the PVC tubing in hot water or gentle heating with a lighter makes it easier to push onto the barb. When installing chemical containers (especially acid), in filter enclosures, which have no ventilation, it is recommended that the hole in the cap of the container is cut to fit tightly around the tubing, so that fumes from the acid or chlorine will not corrode the equipment. It will be necessary to drill a second hole in the cap fitted tightly with a length of tubing which should then be vented outside the filter enclosure. This procedure is recommended only where the filter enclosure has no ventilation and is to protect the equipment.

Note:

The appliance is not intended for use by young children or infirm person without supervision. Please ensure that young children are supervised to ensure that they do not play with the appliance.

If the supply cord is damaged, it must be replaced by the manufacturer or its service agent or a similarly qualified person in order to avoid a hazard.

Power to this controller must be either;

- Supplied by an isolating transformer
- Supplied through a residual current device (RCD) with a rated residual operating current not exceeding 30mA

IMPORTANT: RolaChem pumps dose against a maximum pressure of 150-175 kPA (20-25 psi), avoid excessive pressure situations such as:

In-floor cleaners (when using for pool applications): The recommended position of the injection point and probe is on the suction line.

- ACID SHOULD BE DILUTED MINIMUM 1:2, MORE DILUTION IS OK
- ALWAYS ADD ACID TO WATER (NOT WATER TO ACID)
- NEVER MIX CHEMICALS
- CHEMICALS MUST BE STORED IN ACCORDANCE WITH RELEVANT STANDARDS AND DANGEROUS GOODS CODES. CONSULT YOUR AUTHORISED BUILDER OR POOL SHOP TECHNICIAN FOR ADVICE.

RC9 – PLACEMENT OF CHEMICALS, ROLACHEM AND CONNECTIONS.

Placement of Chemicals

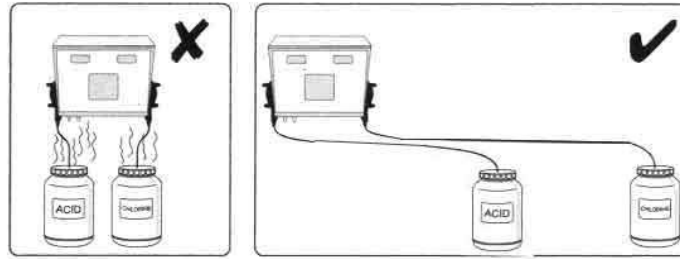

*****Chemicals MUST be stored apart in accordance with Relevant Standards and Dangerous Goods Codes. Consult your authorized builder or pool shop technician for advice. Chemicals must be at least 1 metre horizontally from control unit in a well ventilated area to avoid corrosive damage.**

Placement of Rola Chem Unit

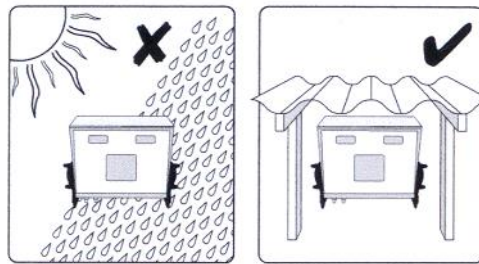

Connection of Lines

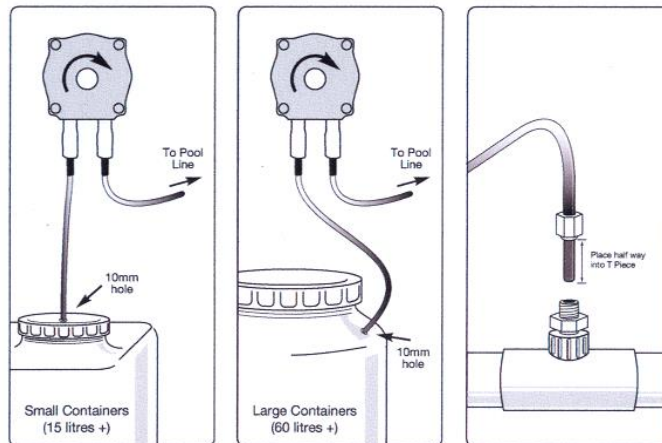

When inserting chlorine and acid tubes into dosing cell, tubes should penetrate approximately 50mm or half way into the depth of the mixing chamber. If the tube has a radius formed which is caused by the memory of the material, it is important that the tube point in the direction of the water flow.

⚠️ Product is designed to run with ACID diluted to water to acid ratio of 2:1 should always be followed as the machines dosing rate is formulated around the diluted solution. Using neat acid can lead to overdosing the pH level.

RCg – INSTALLATION SET UP

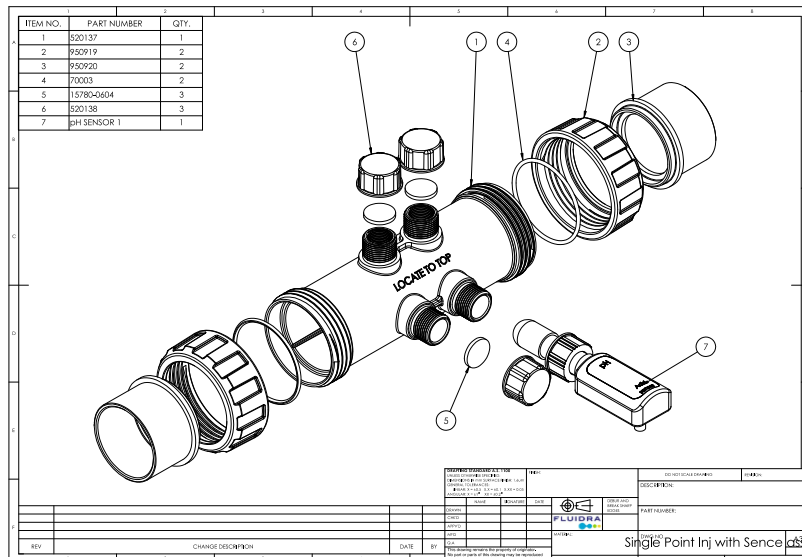
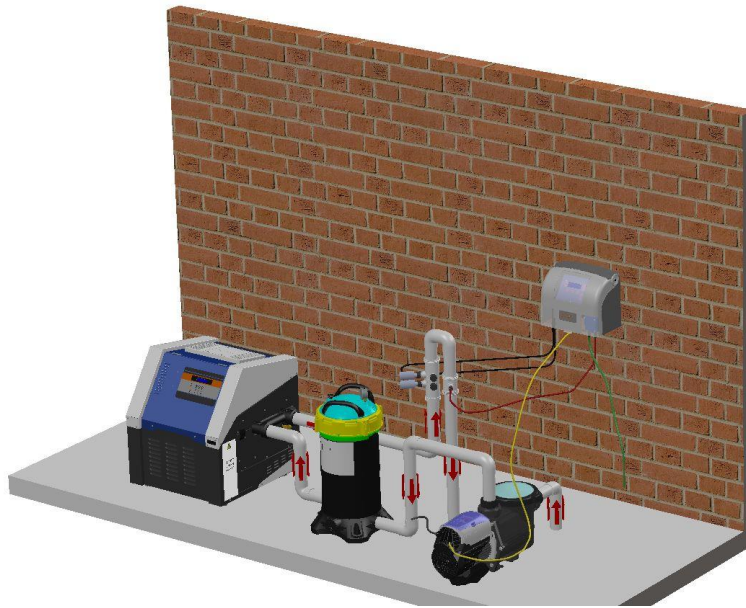

Packed inside your controller there will be a combination of the following items depending on the model of controller ordered;

- a. RCg Controller
 - b. RCg mounting plate
 - c. Intelligent pH probe (if pH model)
 - d. Intelligent ORP probe (if ORP model)
 - e. Mixing chamber – for installation of feed tubes and probes
 - f. Clear supply tube
 - g. Non return valve(s)
 - h. Hose weight(s)
 - i. Alligator clamps
1. Begin installation by plumbing the mixing chamber into the return line of the swimming pool. The mixing chamber should be installed after gas heaters and solar take offs and returns but before any other sanitising device such as salt chlorinators or erosion feeders. When installing the mixing chamber, it is essential the probes are horizontal to the water flow. This ensures the probes are constantly submerged even when water flow is restricted.



✓



X

2. Locate position for mounting plate where equipment will receive greatest protection from direct sunlight and rain. Ensuring plate is level, screw into a solid wall or post using 4 holes provided.

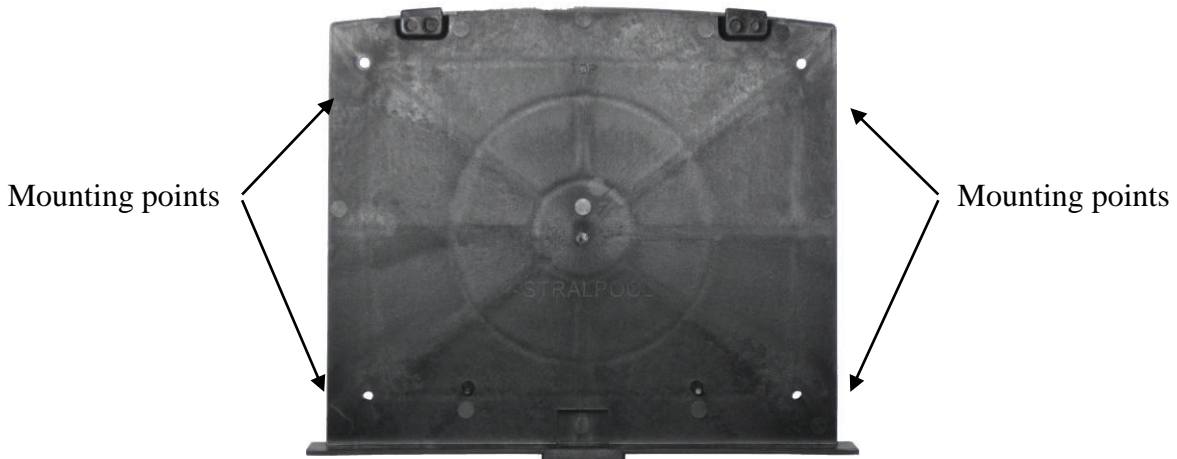

3. Once mounting plate is secure, locate RC9 control box onto the 2 locating tabs at the top. The bottom of the control box should then “snap” into place with light pressure on the locking device of the mounting plate.
4. Connect power cable from RC9 control box to GPO or pool and spa controller if applicable.
5. Raise front cover of RC9 controller to expose dosing pumps.
6. Measure required length of clear supply tubing to reach from dosing pump to mixing chamber. Be sure to allow an additional 100mm of tubing so it can be fed into the return pipe work downstream of the mixing chamber.
7. Measure required length of clear supply tubing to reach from dosing pump to chemical supply drum. Be sure to allow enough tubing so it can reach to the bottom of the drum / container.
8. Attach tubing for the mixing chamber to the outlet (right hand) barb fitting of the dosing pump squeeze tube. Attach the tubing for the supply drum / container to the inlet (left hand) barb fitting. Once tubes are fitted to barbs, attach alligator clamps to hose to secure it to the barb.

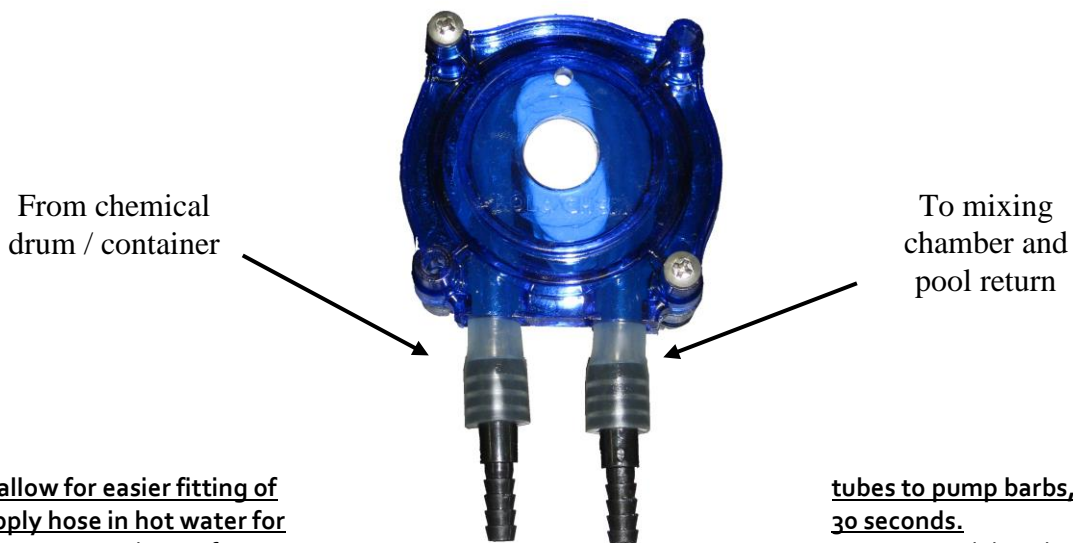

Tip – to allow for easier fitting of clear supply hose in hot water for

9. Remove probe(s) (if and carefully take off the tip. Insert probe into mixing chamber and finger tighten only. DO NOT OVER TIGHTEN.

tubes to pump barbs, soak end of 30 seconds.

model applicable) from carton rubber protective cover from

- Fit chemical feed tube(s) to mixing cell through glands provided, feeding approx 50mm of tube down return to pool pipe work.

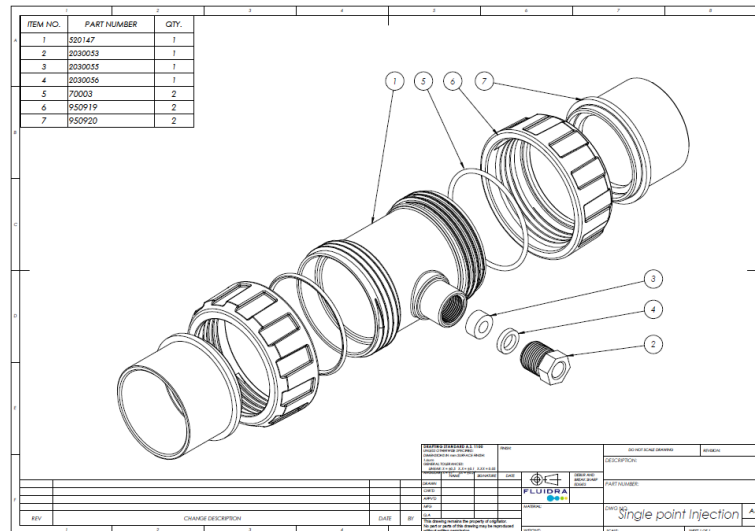

- Fit chemical feed tube(s) to supply drums/containers. This should be done by feeding the tube through a tight fitting hole in the lid of the container. Once fed through, fit hose weight and non return valve to the end of the tube. A breather hole should also be made in the chemical container. If being stores in a plant room or similar enclosed area, an additional tube should be run from the breather hole to outside of the equipment/plant room.

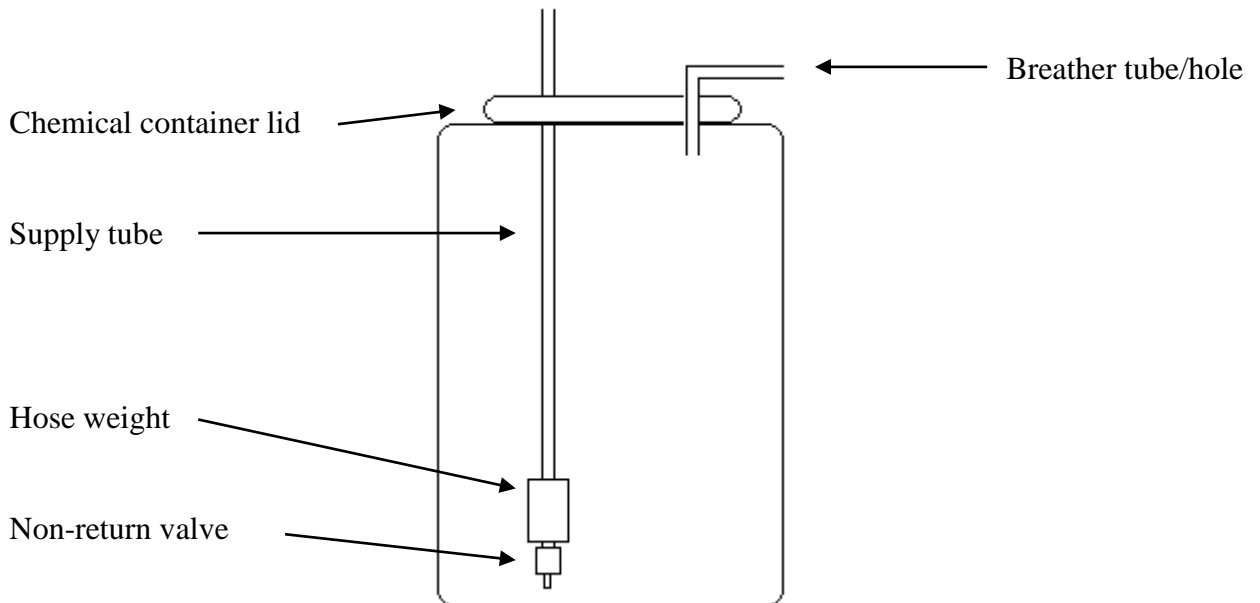

- Connect cable from pH underside of RC9 controller.

and/or ORP probe to socket on

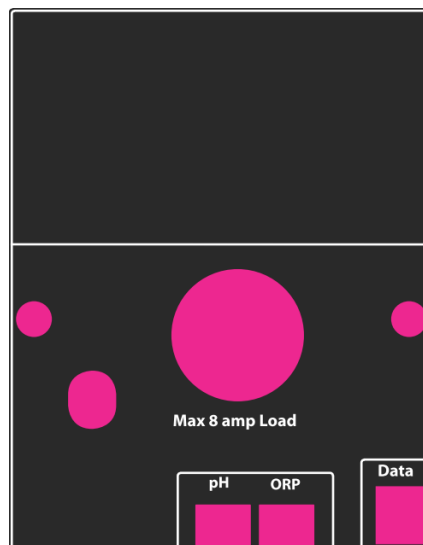

13. Turn power on to the RCg controller. The main screen will be shown after a short period.

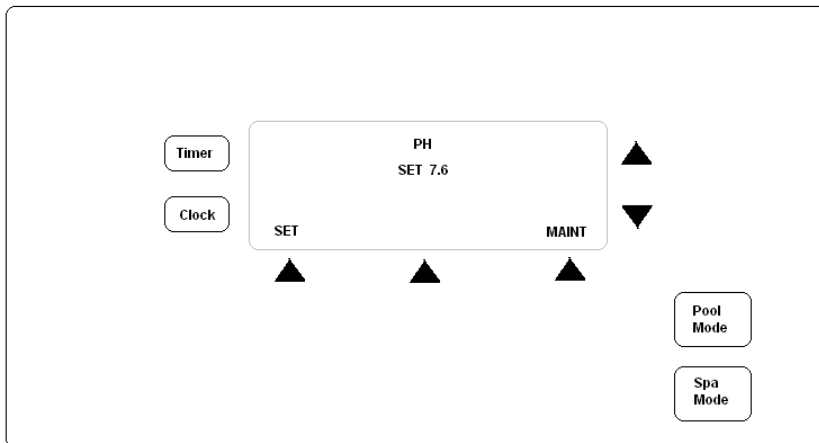

14. Press button located under the "MAINT" option and the following screen will be displayed;

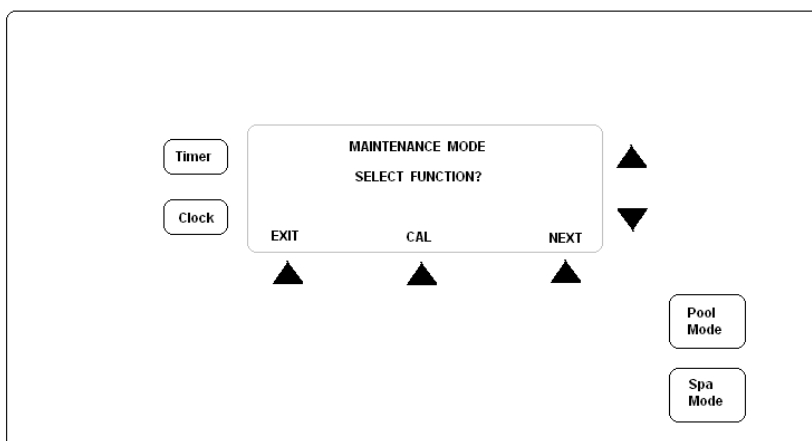

Select the "NEXT" option and the following screen will be shown;

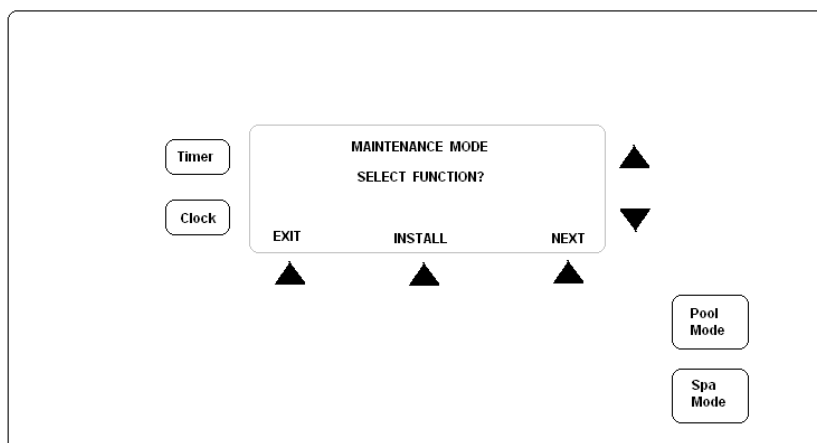

Select the "INSTALL" option

15. "SET WATER VOLUME" will be shown, select YES and adjust volume to match pool. You will need to set levels for both Pool and Spa. If no spa is attached, just leave spa volume on default size. Press ACCEPT.
16. "CHLORINE SENSOR" (if a chlorine dosing unit) will be shown. You can select either ORP or OPTO-MIZER using the arrows to the right of the screen.
17. "ENABLE ALARM" allows you to select if an audible alarm will sound if either the ORP, PPM or pH readings go outside of the minimum or maximum set levels. Choose YES or NO. If YES is selected, you will need to set maximum and minimum levels before the alarm will sound.

18. If Optimizer option is selected and fitted, you can change the Optimizer measure cycle time. This can be set between 6 – 40 minutes. The lower this is set the more often the unit will measure and dose your pool water.
19. "TIMER" is set default to ENABLED. If you are using an AstralPool controller or similar, change this to NOT ENABLED. If NOT ENABLED is selected, you will be asked if a G4 system is installed. Select installed for all compatible AstralPool controllers including Viron Connect, Genus 4 and Genus 3 controller. For all non AstralPool controllers, select NOT INSTALLED to this option.
20. "FAST COMMS" is only used when a Viron Connect touch screen controller is connected to the RC9 dosing system. If a Viron Connect system is connected, change this option to ENABLED. For all other controllers, this option needs to be changed to NOT ENABLED.
21. "FLUSH AFTER TIMER" will bring the filtration pump on momentarily to flush out any residual chemicals from the mixing cell. This will occur approximately 30 minutes after the timer period has finished. This should be left YES (this option is only shown where the TIMER has been enabled)
22. "RESET SYSTEM" select NO

The installation set up is now complete.

RC9 – TIMER SET UP (ONLY IF TIMER SELECTED)

1. Using the POOL MODE button, switch the RC9 to manually off.
2. Press the CLOCK button to the left of the screen and you will have the following options;

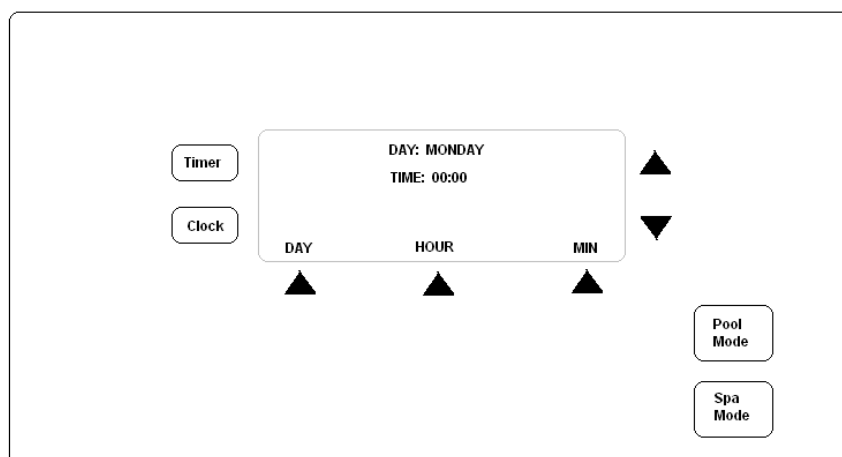

3. To change the day, press the DAY button first then use the up and down arrows. Repeat for the HOUR and MIN settings. Once complete, press the CLOCK button.
4. Press the TIMER button to the left of the screen and you will have the following options;

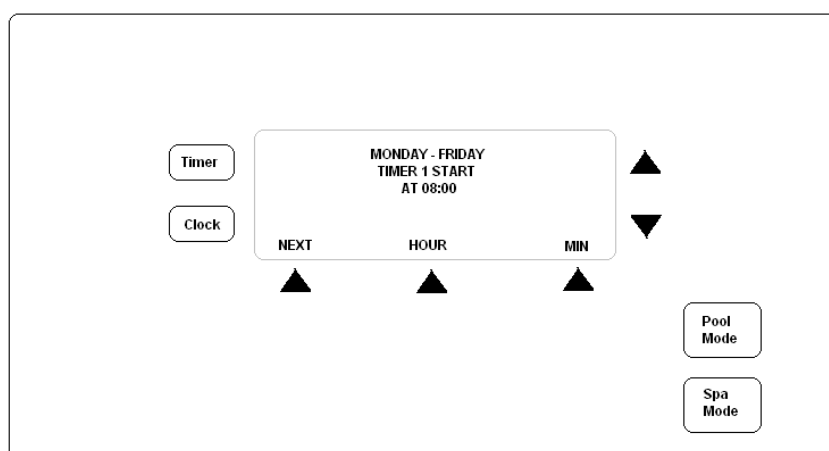

5. Using the up and down arrows in conjunction with the HOUR and MIN buttons, set the time you want the filtration pump to start at. Press NEXT when done.

6. Using the up and down arrows in conjunction with the HOUR and MIN buttons, set the amount of time you want the filtration pump to run for. (Note: You are not setting an off time, you are setting a run period). Press NEXT when done.
7. Repeat steps 5 & 6 for timer period 2 and for Saturday-Sunday periods.

Note: In the event you cannot increase the start time for the period, it will most likely be caused by the set run time going beyond midnight. When setting timers, you cannot set period to run past midnight as this will cause conflict between Mon-Fri settings and Sat-Sun settings. For night time running, set your first period to run up until 23:59 and your second period to start at 00:01.

PLEASE NOTE:

Each time RC9 starts up in Automatic, it will be on pre-purge for 5 minutes. The display shows:

PRE_PURGE

This allows time for accurate sensing and proper mixing before dosing commences. For service needs, press Pool Mode to get to Manual On and there will be no Pre-purge

RC9 – ORP AND/OR PH SET POINT ADJUSTMENT

1. The factory default set points are;

- | | | | |
|-----|-----|---|-------|
| i. | pH | - | 7.6 |
| ii. | ORP | - | 700mV |

As all pools are different in construction, it may be necessary to change the set points. To ensure warranty on your pool shell /surface, the required levels should be set under guidance from your pool builder or other pool professional

2. To change the settings for either ORP or pH, switch the controller into the manually off position using the POOL MODE button, then select the SET button from the main screen.

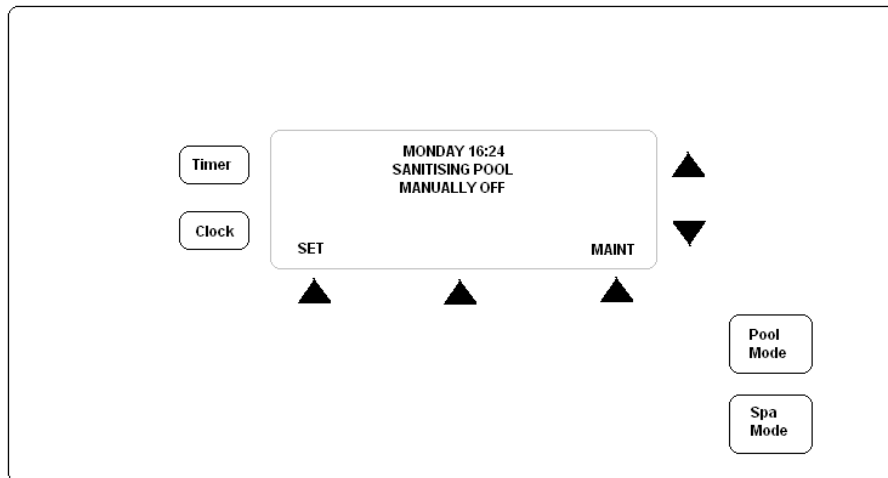

3. The screen will display "Change pH Set Point?" Select Yes or No.
4. Using the Up and Down arrows to the right of the screen change set point if required. Select ACCEPT when done.
5. Repeat process for ORP setting also.

RC9 – ORP AND/OR PH MANUAL DOSING

1. Using the POOL MODE button, switch the RC9 to manually off.
2. Select the MAINT option and the following screen will be shown;

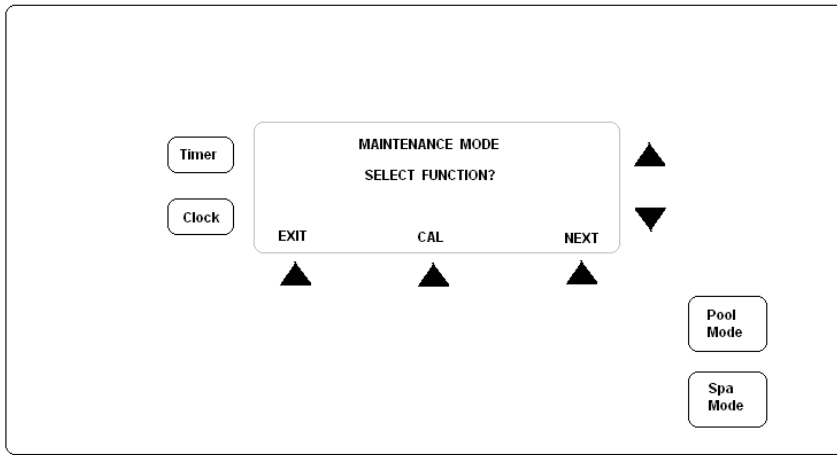

3. Press NEXT button twice so that the middle button displays DOSE. Press DOSE button.

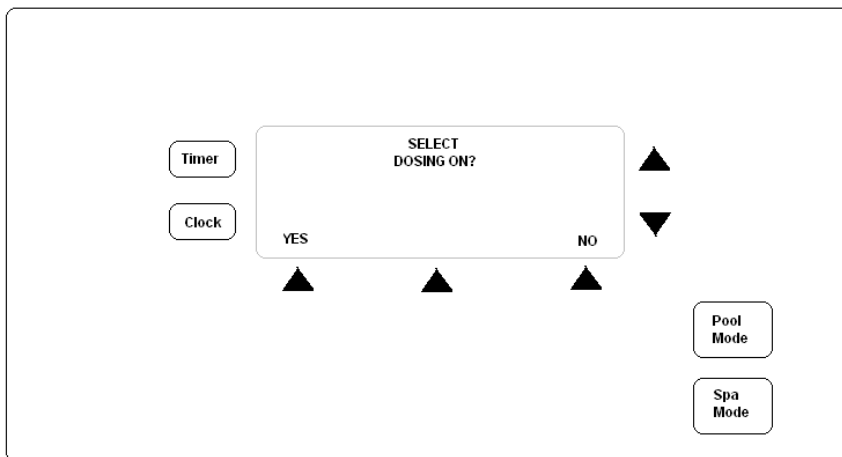

4. Select YES. You will be give the option to dose either Acid or Chlorine, pick the one you are wishing to dose. You will then need to set the dosing time/quantity using the up and down arrows to the right of the screen. You can choose to dose by volume of liquid or time period. Once you have set the volume/time to be dosed, select ACCEPT.
5. You will be prompted to select the mode of the controller after the manual dosing has completed.
 - i. AUTO - Will switch the controller back to Auto/Timer mode after dosing has completed
 - ii. ON - Controller will switch to manually on and continue to operate until switched off or back to Auto
 - iii. OFF - Controller will switch Off and remain Off.

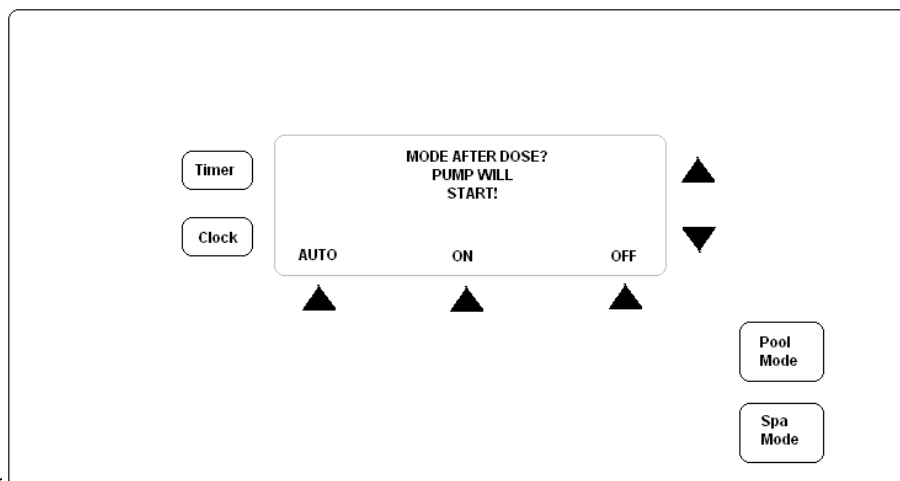

RC9 – ORP AND/OR PH PROBE CALIBRATION

- Using the POOL MODE button, switch the RC9 to manually off. Before proceeding, clean the probe to be calibrated with an abrasive crème cleanser such as Jiff. DO NOT USE ACID. Once cleaned, flush with water and allow to sit for 4 – 5 minutes before continuing with calibration.
- Select the MAINT option and the following screen will be shown;

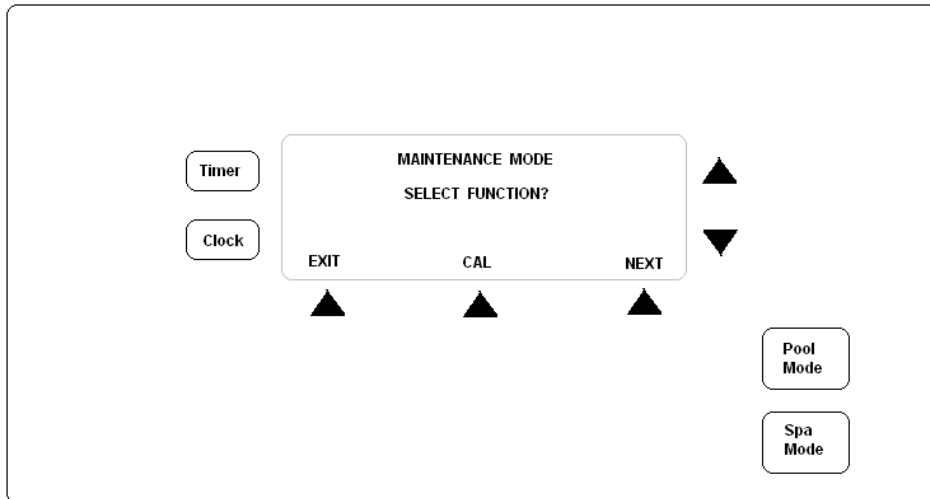

- Select CAL option. Then select either PH or ORP calibration based on the option provided.
- Once you have selected which probe you wish to calibrate you will be asked "Select Filter Pump On?" This option decides if the filtration pump is to be running during the calibration process.
 - If you are calibrating by leaving the probes in the mixing cell and using the pool water for reference, select YES.
 - If you are using a calibration solution (available from AstralPool dealers) select NO.
- Once you have selected Yes or No, the display will indicate the unit is measuring the current level. Once the reading is completed, the current pH or ORP reading will be displayed on the screen. Using the Up and Down arrows, change the reading to reflect the calibration solution level or the tested water level. Press ACCEPT.
- Repeat if required on other probe.

RC9 – ORP AND/OR PH FAULT WARNING INDICATORS

Alarm messages are displayed on the LCD display and more information can be obtained by pressing the **INFO** button which appears when an error occurs. The info button also mutes the audible alarm. The Error message will continue to flash on the screen until the fault(s) are rectified. Typical faults are:

- High or low chemical levels: This indicates that the pH or ORP are outside set limits
- SENSOR FAULT: This indicates that there is a problem with the pH or ORP sensing system. Potential issues could be that the sensor is not connected or that the sensor requires cleaning.

Possible causes for faults

Low Chlorine	High Chlorine
<ul style="list-style-type: none"> Chlorine drum is empty Filter: run timing is not sufficient or requires back washing Stabiliser level is low (outdoor pools) pH is too high 	<ul style="list-style-type: none"> pH is too high High total dissolved solids (TDS) Excess stabiliser level (outdoor pools) Oversized dosing pump Probe malfunction

<ul style="list-style-type: none"> Poor water circulation Injection point at delivery end is blocked Dosing pump is undersized Probe malfunction 	
Low pH <ul style="list-style-type: none"> Poor water circulation Excessive rainfall (neutralising TA) Faulty dosing pump Probe malfunction 	High pH <ul style="list-style-type: none"> Acid drum is empty Acid is over-diluted Filter: run timing is not sufficient or requires back washing Probe malfunction

RC9 – MAINTENANCE

- Lubricate the squeeze (pump) tube every 6 months, more often in commercial applications. Use only the recommended lubricant "RC Tube Lube" available from AstralPool dealers or any other compatible silicone lubricant, otherwise damage to the tube is possible. Do not use any petroleum based lubricants.
- Depending upon usage, the squeeze tube may need replacement after 12months on a domestic installation, and earlier on a commercial installation. Before replacing the tube make sure that any stop valves in the filter system are closed. Otherwise water loss may occur.
 - To replace the tubes, remove the retaining screws and the pump head and pull the tube free. Disconnect the squeeze tube from the barbs and fit the new squeeze tube. Ensure the new tube has sufficient lubrication. Make sure that the new tube is correctly connected to the PVC tubing as per instructions. Reposition the squeeze tube in the unit as before, replace the pump head and retaining screws. **PLEASE DO NOT OVERTIGHTEN THE RETAINING SCREWS**
- The Injection Point through which the chemical discharges into the pipeline should be checked periodically for any build up of solid matter in the end of the PVC tubing and kept clean. Blockages can be caused by stale or poor quality chlorine or improper water chemistry. This may cause blockages and not allow the chemical to pass through the line and will alter the pH or ORP levels and may cause the squeeze tube to come off the barbs
- The probes/sensors are sensitive instruments. To maintain their accuracy they should be cleaned periodically by household detergent abrasive like Jiff. Jiff is the preferred option. The ORP probe tip can be contaminated (generally observed by a copper or brownish coating – this should always look shiny silver) which will give a false reading to the Controller causing no dosing/over dosing of chemical. As the pH sensor tip is made of glass, please take care, for even a hair line crack can cause the sensor to read incorrectly causing malfunction.
- After cleaning the sensors/probes, wash with water, allow 5-10min. to settle and check calibration or re-calibrate if necessary. **Copper based algaecides should be avoided, but if used the cleaning procedure for the ORP sensor can be more frequent, as copper will coat the sensor tip (made of platinum) more rapidly.**

USE OF A SUN SCREEN CHEMICAL (CYANURIC ACID) FOR OUTDOOR POOLS IS RECOMMENDED.

CHECK WITH YOUR LOCAL POOL SHOP AND USE THE CORRECT DOSAGE. MAKE SURE YOUR POOL WATER IS WELL BALANCED WITH THE CORRECT pH, TDS, TA AND STABILISER LEVELS AND FREE FROM PHOSPHATES.

RC9 -TROUBLE SHOOTING GUIDE

TROUBLE	POSSIBLE CAUSE/SOLUTION
pH reading incorrect	<ul style="list-style-type: none"> * Clean the sensor. * Check calibration of sensor in the pH cal. sol. * Check water balance & correct if reqd.
ORP reading incorrect	<ul style="list-style-type: none"> * Clean sensor. * Check calibration of sensor in ORP Cal. sol. * Check water balance, especially pH.
Dosing pump does not operate as it should	<ul style="list-style-type: none"> * Is Setpoint level altered?
The Roller (H) Block on the inside of the unit does not dispense chemicals	<ul style="list-style-type: none"> * No chemicals in the tank. * Injection point blocked. * Air leak at the connection where the tube from the drum connects onto the pump tube. * Chemical container airtight. * Roller or H block broken. * Pump head cracked.

- * Squeeze tube needs replacement.
 - * Check last 3 points above. Replace non-return Valve if fitted. If not please fit.
 - * Turn off for 15 minutes, and then restart. If still no response, contact AstralPool Service.
- Water returns to the chemical drum**
- Numbers not appearing on display panel, no lights or power**

IMPORTANT: ELECTRICAL SPIKES/SURGES OR SIMILAR SITUATIONS CAN EFFECT THE ELECTRONICS & SENSORS AND CAUSE THE MACHINE TO MALFUNCTION. IT IS NECESSARY TO CHECK THE WATER CHEMISTRY, ESPECIALLY PH AND CHLORINE LEVELS REGULARLY WITH A GOOD QUALITY TEST KIT AND LOOK OUT FOR ANY MALFUNCTIONS.

IF THE PH AND/OR ORP READING ON THE RC MACHINE ARE OUT OF NORMAL RANGE PLEASE TURN THE MACHINE OFF AND CALL A POOL TECHNICIAN OR ASTRALPOOL

ALWAYS USE GENUINE ROLA CHEM PARTS.

AstralPool reserves to change product specifications without notice.

Please check AstralPool web site at www.astralpool.com.au for updates before installing or servicing Rola Chem units.

RC9 – MAINTENANCE SCHEDULE

You new product incorporates moving parts and withstands high velocity water with chemicals in it. Some of these parts will wear in the normal course of use and require regular checks and maintenance. Performing these checks and maintenance will identify parts that have worn and require repair/replacement before further serious damage is sustained. A small amount of regular care and attention to your pool equipment will help ensure long life and trouble free performance.

Timing	Maintenance Check	Service action (if required)
Fortnightly	Check acid / chlorine drums	Fill drums, use a 2:1 mixture for acid
Three Monthly	Check supply tubes for blockages	Cut ends off supply tubes if build up of scale and reconnect
	Check pH and ORP probes	Clean with abrasive crème cleanser (do not use acids), reassembly and allow at least 1 hour for sensing to return to normal
	Check non return valves in drums	Replace if required
Six Monthly	Check output settings and adjust	Adjust timer / output settings based on season, weather and pool usage
	Check squeeze tubes	Apply grease if required, replace if leaking
	Spray around equipment for insects	Spray on surrounding walls, do not spray directly into appliance
	Recalibrate sensors	Follow instructions in this manual
Annually	Check all connections, o’rings and tubing	Call Service technician to perform annual checks and routine maintenance

Important note: Regular maintenance is important to ensure long life and trouble free performance of your pool equipment. If unable to perform the maintenance yourself, contact your local AstralPool office who will arrange a trained service technician to perform the maintenance for you.

Record your Equipment details here for quick reference:

Model No.: _____

Serial No.: _____

WARRANTY

AstralPool Australia Pty Ltd (ABN 97 007 284 504) ("AstralPool") provides the following warranty in relation to its RC9 series Dosing Controller ("Product").

The benefits of this warranty are in addition to any rights and remedies imposed by Australian State and Federal legislation that cannot be excluded. Nothing in this warranty is to be interpreted as excluding, restricting or modifying any State or Federal legislation applicable to the supply of goods and services which cannot be excluded, restricted or modified.

WARRANTY

AstralPool warrants that, subject to the exclusions and limitations below, the Product will be free from defects in materials and workmanship during the warranty period. The warranty periods are set out below and commence 30 days after the date of purchase (to allow for installation). The warranty period may vary for different parts of the Product.

Parts	Warranty Period
Control box including PCB's	5 years pro rata 0% payable of invoice total year 1 20% payable of invoice total year 2 40% payable of invoice total year 3 60% payable of invoice total year 4 80% payable of invoice total year 5
pH and chlorine Sensors, dosing motor/gearbox and associated tubing/fittings	12 months

If a defect appears in the Product before the end of the warranty period and AstralPool finds the Product to be defective in materials or workmanship, AstralPool will, in its sole discretion, either:

- (a) Replace or repair the Product or the defective part of the Product free of charge; or
- (b) Cause the Product or the defective part of the Product to be replaced or repaired by an Authorised AstralPool Service Agent free of charge.

AstralPool reserves the right to replace defective parts of the Product with parts and components of similar quality, grade and composition where an identical part or component is not available.

Goods presented for repair may be replaced by refurbished goods of the same type rather than being repaired. Refurbished parts may be used to repair the goods.

WARRANTY CLAIMS

1. If a fault covered by warranty occurs, the customer must first contact AstralPool at the contact address listed below, or an Authorised AstralPool Service Agent.
2. Any warranty claim must be accompanied by:
 - (a) Proof of purchase;
 - (b) Full details of the alleged defect; and
 - (c) Appropriate documentation (such as historical and maintenance records).
3. The customer must make the Product available to AstralPool or its Authorised AstralPool Service Agent for inspection and testing. AstralPool or its Authorised AstralPool Service Agent will attend the premises where the Product is installed for inspection and testing. If the Product is installed:
 - (a) Outside a capital city metropolitan area; and
 - (b) is not within a 20 km radius of an Authorised AstralPool Service Agent;Then the customer may have to pay a travel fee.
4. If such inspection and testing finds no defect in the Product, the customer must pay AstralPool's usual costs of service work and testing. If such inspection and testing finds a defect that is not covered by this warranty, the customer must pay AstralPool's usual costs of service work plus any parts and labour required to repair the Product, unless recoverable from AstralPool on the failure of any statutory guarantee under the ACL.

Exclusions

The warranty will not apply where:

- (a) The customer is in breach of the Terms and Conditions of Sale;
- (b) The Product was used for a purpose other than one it was intended for;
- (c) The Product was repaired, modified or altered by any person other than AstralPool;
- (d) The Product has not been installed, maintained and/or operated in complete compliance with the installation and operating instructions and any instructions by AstralPool;
- (e) The Product has been subject to accident, negligence, alteration, abuse or misuse.

The warranty does not extend to:

- a) Normal wear and tear;
- b) Weather and other environmental conditions including but not limited to storm, flood, and/or heat wave damage;
- or
- c) Service and maintenance items.

Examples of exclusions include but are not limited to:

- Cleaning and calibration of probes

Commercial Installations

On commercial installations, such as health clubs, motels/hotels and hydrotherapy facilities, the warranty is limited to parts and in field labour (within capital city metropolitan areas or 20 km radius of Authorised AstralPool Service Agents) for a period of 12 months from the date of purchase plus 30 days to allow for installation.

LIMITATIONS

AstralPool makes no express warranties or representations other than set out in this warranty.

The repair or replacement of the Product or part of the Product is the absolute limit of AstralPool's liability under this express warranty.

Our goods come with guarantees that cannot be excluded under the Australian Consumer Law. You are entitled to a replacement or refund for a major failure and for compensation for any other reasonably foreseeable loss or damage. You are also entitled to have the goods repaired or replaced if the goods fail to be of acceptable quality and the failure does not amount to a major failure



INST291



sales@astralpool.com.au
www.astralpool.com.au